





Parte esterna monocomando doccia incasso VITA_VI003000



MODELLO **VI003000**

Parte esterna monocomando doccia incasso, senza parte incasso, per art. ZA005300

FINITURE DISPONIBILI

-  **21** 21 Cromo
-  **2Q** 2Q Black Titanium
-  **40** 40 Nero Opaco
-  **4Q** 4Q Bianco Opaco

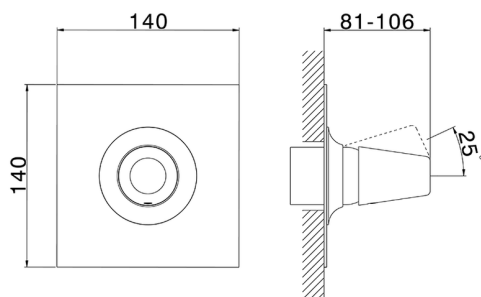

CARATTERISTICHE

Installazione **Incasso**
 Parti Incasso necessarie **ZA005301**
ZA005300



Parte esterna monocomando doccia incasso VITA_VI003000

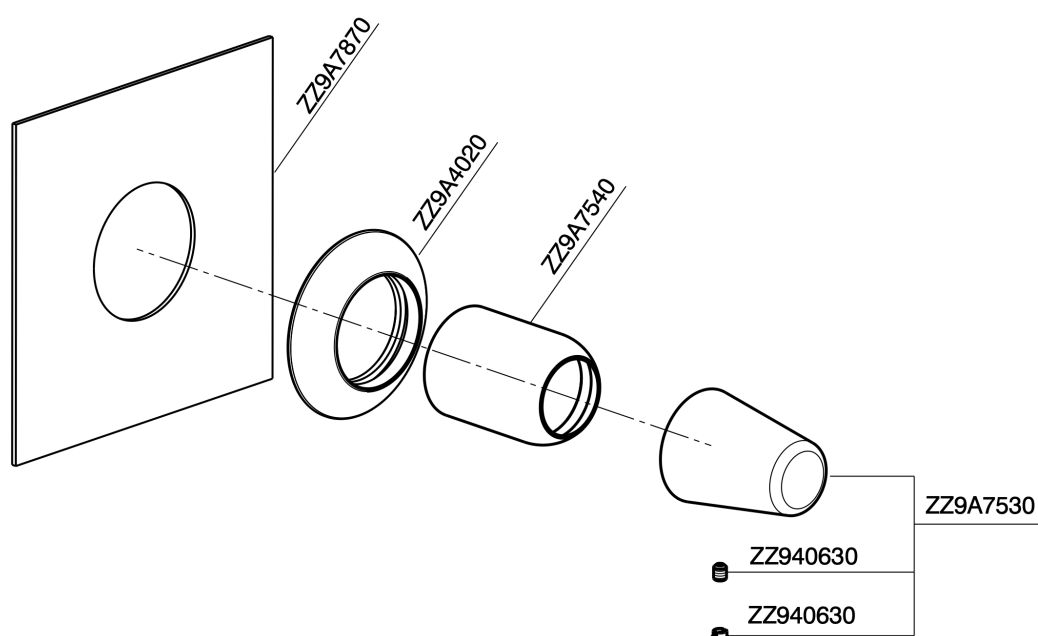

VI003000

<https://www.cisal.it/parte-esterna-monocomando-doccia-incasso-vitavi003000>

Parte incasso monocomando doccia INCASSO_ZA005301

MODELLO **ZA005301**

Parte incasso monocomando doccia, doccia incasso 1/2", senza parte esterna, con silenziatori



FINITURE DISPONIBILI



04 04 Senza Finitura

CARATTERISTICHE

Ricambio Cartuccia **ZZ94035000**

Incasso **1**

Cartuccia Monocomando 35 mm

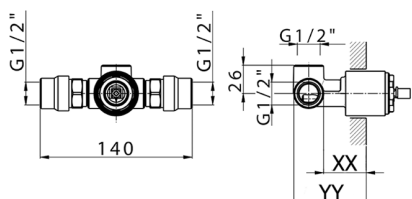

Piastra/Plate/Plaque/Platte/Placa
 2-3mm: XX 27-47 YY 54-74
 10mm: XX 16-40 YY 43-68



Parte incasso monocomando doccia INCASSO_ZA005300

MODELLO **ZA005300**

Parte incasso monocomando doccia, doccia incasso
1/2", senza parte esterna



FINITURE DISPONIBILI



04 04 Senza Finitura

CARATTERISTICHE

Ricambio Cartuccia **ZZ94035000**

Incasso **1**

Cartuccia Monocomando 35 mm

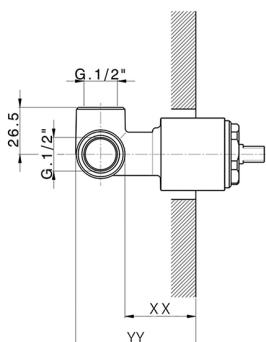

Piastra/Plate/Plaque/Platte/Placa
2-3mm: XX 27-47 YY 54-74
10mm: XX 16-40 YY 43-68



2024-01-15